

MODEL: SIM-4-A | **DESCRIPTION:** SIM CARD CONNECTOR**FEATURES**

- SIM card connector
- push in, auto eject out
- card detect switch
- gold flash
- surface mount
- UL94V-0

**SPECIFICATIONS**

| parameter | conditions/description | min | typ | max | units |
|---------------------------------|-----------------------------------------|-------|-------|-----|--------|
| rated voltage | | | | 30 | V |
| rated current | | | | 0.5 | A |
| contact resistance ¹ | | | | 100 | mΩ |
| insulation resistance | at 500 Vdc, between adjacent circuits | 1,000 | | | MΩ |
| voltage withstand | for 1 minute, between adjacent circuits | | 100 | | Vac |
| insertion force | at a rate of 25 mm/min | | | 10 | N |
| withdrawal force | at a rate of 25 mm/min | 0.5 | | | N |
| life | | | 5,000 | | cycles |
| operating temperature | | -40 | | 85 | °C |
| flammability rating | UL94V-0 | | | | |
| RoHS | yes | | | | |

Note: 1. When measured at 20 mV / 100 mA.

SOLDERABILITY

| parameter | conditions/description | min | typ | max | units |
|------------------|------------------------------------------------------------------------------------------------------------|-----|-----|-----|-------|
| reel storage | at relative humidity 40~70% reel opened: use within 1 month reel unopened: up to 15 month shelf life | 16 | 22 | 28 | °C |
| reflow soldering | see reflow profile | | | 250 | °C |

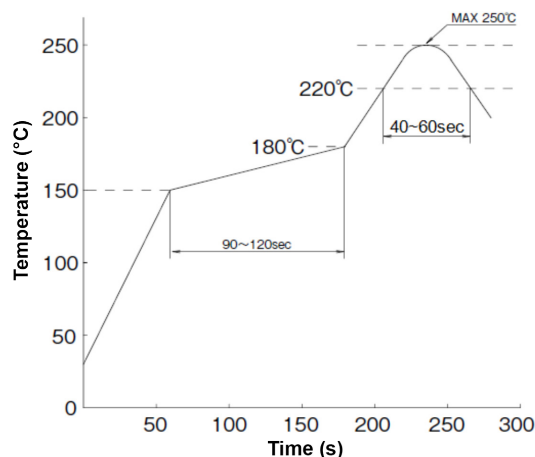

MECHANICAL DRAWING

units: mm
 tolerance:
 X.X ±0.30 mm
 X.XX ±0.20 mm
 X.XXX ±0.10 mm
 unless otherwise specified

| DESCRIPTION | MATERIAL | PLATING/COLOR |
|-------------------|------------------------------|-----------------------------------------------------------------------------------|
| housing | LCP 30% GF (UL94-0) | black |
| contact terminals | phosphor bronze t=0.15 mm | contact area: gold flash over nickel solder area: gold flash over nickel |
| cover | SUS304 t=0.15 mm | solder area: gold flash over nickel |

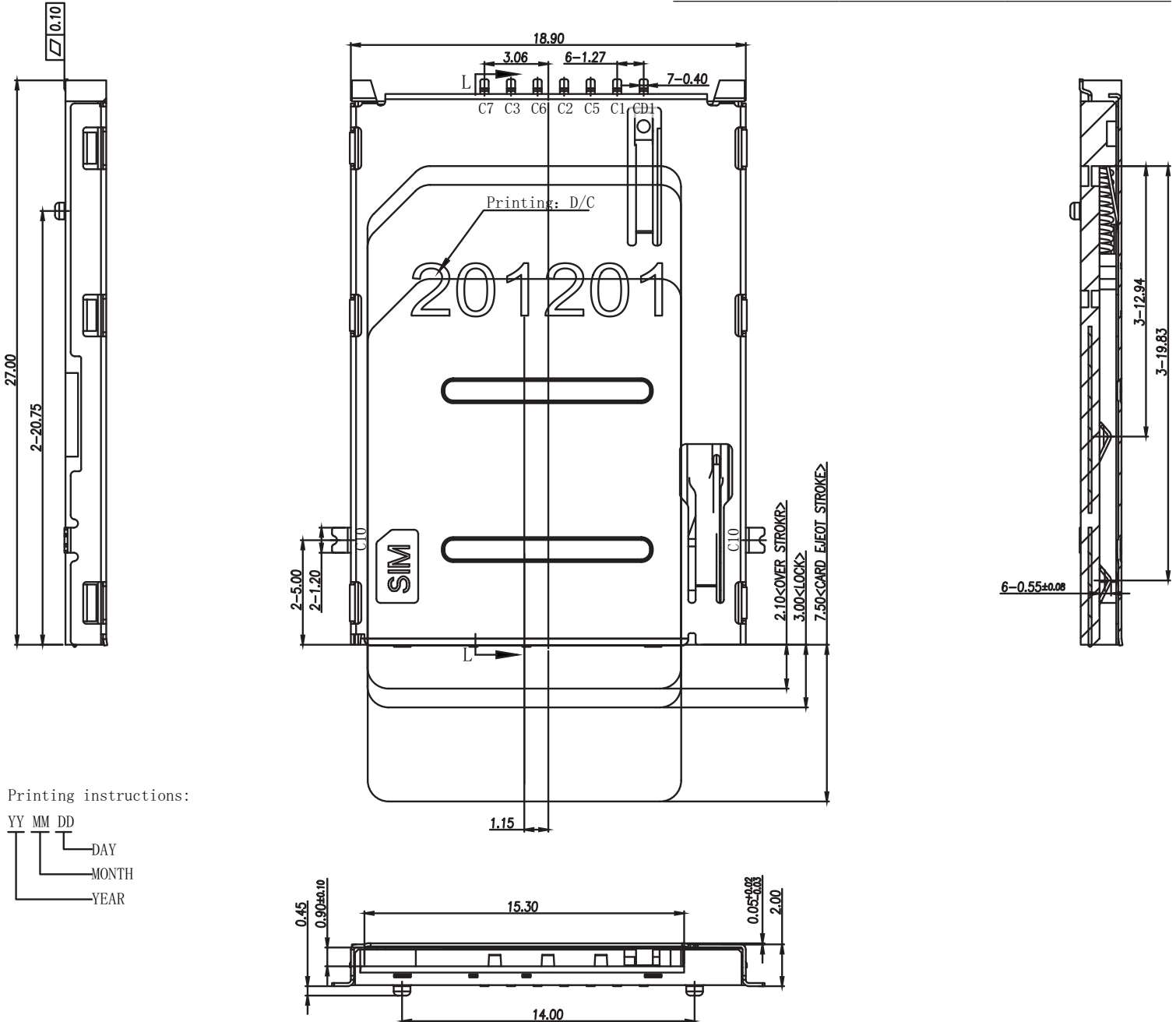

Printing instructions:

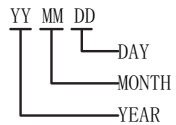



MECHANICAL DRAWING (CONTINUED)

units: mm
PCB tolerance: ±0.05 mm

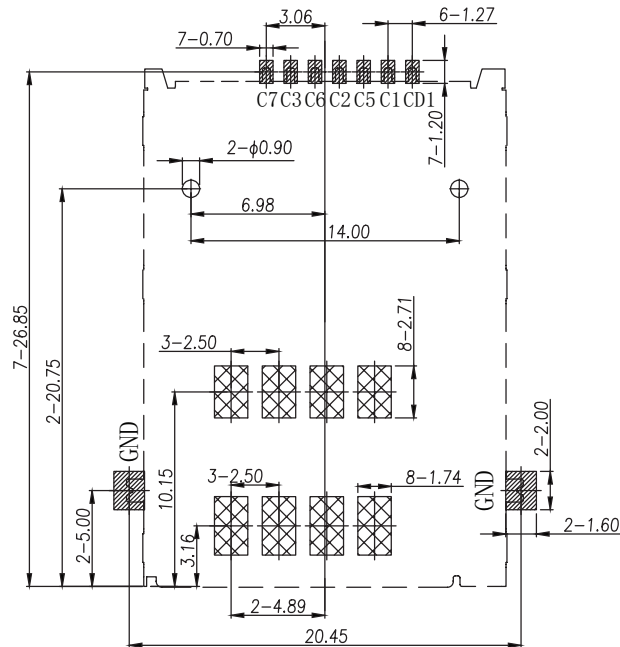
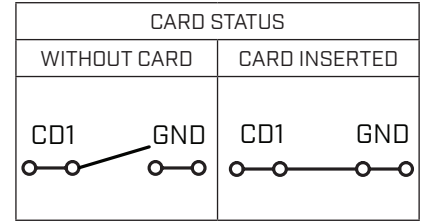
| PIN CONNECTIONS | | |
|-----------------|-------------|---------------------|
| PIN | SIGNAL NAME | DESCRIPTION |
| C1 | VCC | SUPPLY VOLTAGE |
| C2 | RST | RESETTING |
| C3 | CLK | CLOCK |
| C5 | GND | GROUND |
| C6 | VPP | PROGRAMMING VOLTAGE |
| C7 | I/O | DATA LINE |
| CD1 | - | CARD DETECT SWITCH |



-  SMT SOLDER AREA
 -  COPPER RESTRICTED AREA
 - 1. TOUCH AREA OF CONTACT TIPS NO ELECTRICAL FUNCTION
 - 2. NO FIRST PCB_LAYOUT CIRCUITS IN THE AREA
- Recommended PCB Layout
Top View

PACKAGING

units: mm

Reel Size: $\varnothing 330$ mm

Reel QTY: 600 pcs per reel

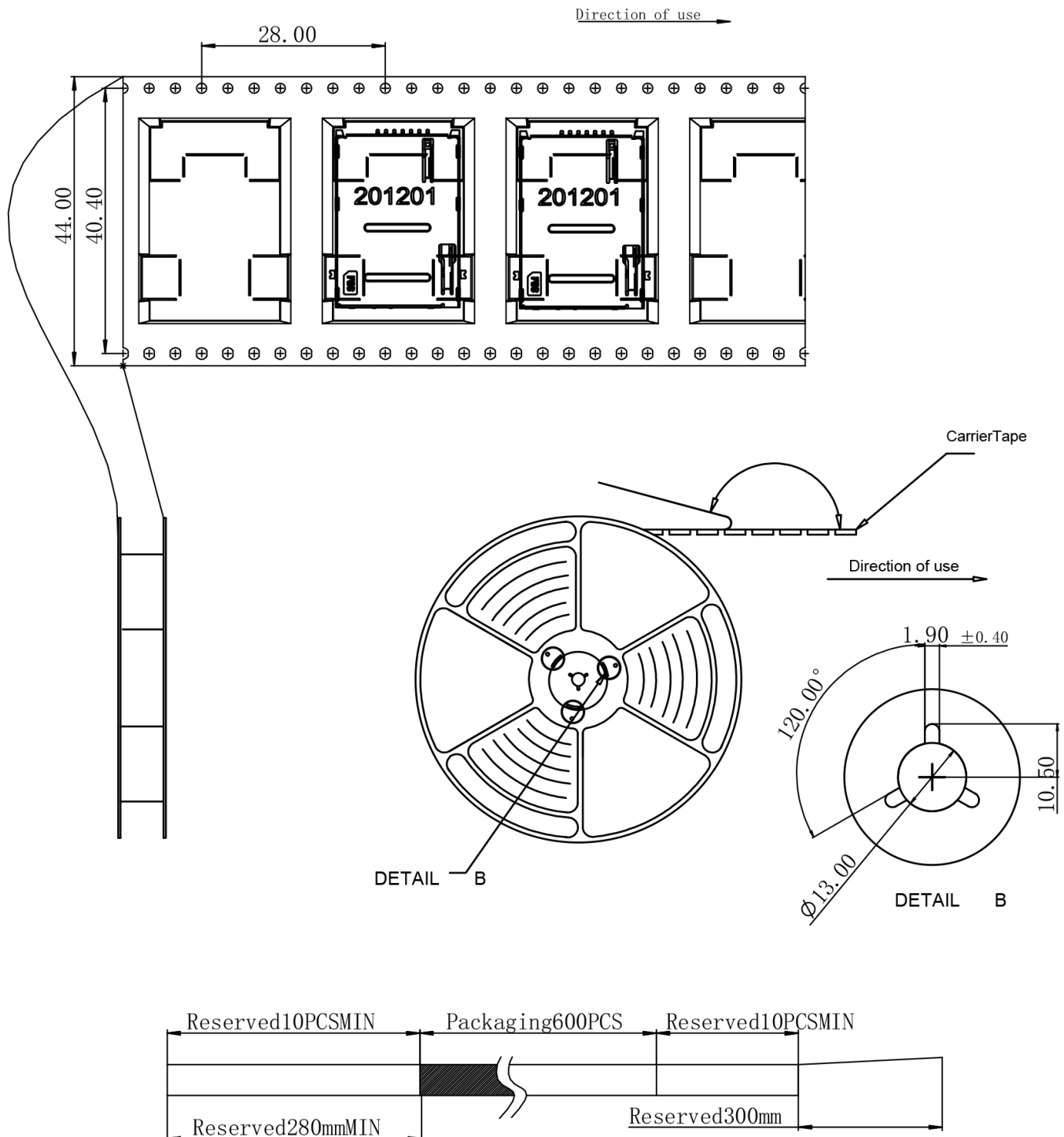

REVISION HISTORY

| rev. | description | date |
|------|-----------------|------------|
| 1.0 | initial release | 10/23/2023 |

The revision history provided is for informational purposes only and is believed to be accurate.



CUI Devices offers a one (1) year limited warranty. Complete warranty information is listed on our website.

CUI Devices reserves the right to make changes to the product at any time without notice. Information provided by CUI Devices is believed to be accurate and reliable. However, no responsibility is assumed by CUI Devices for its use, nor for any infringements of patents or other rights of third parties which may result from its use.

CUI Devices products are not authorized or warranted for use as critical components in equipment that requires an extremely high level of reliability. A critical component is any component of a life support device or system whose failure to perform can be reasonably expected to cause the failure of the life support device or system, or to affect its safety or effectiveness.

cuidevices.com