

MODEL: HSB40-252510P | **DESCRIPTION:** HEAT SINK

FEATURES

- BGA design
- push pins
- aluminum alloy
- black anodized finish

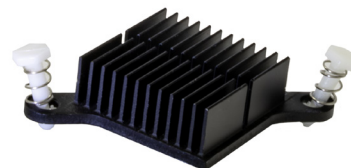

MODEL

	thermal resistance ¹				power dissipation ¹ @ 75°C ΔT, nat conv [W]
	@ 75°C ΔT, nat conv [°C/W]	@ 1 W, nat conv [°C/W]	@ 1 W, 200 LFM [°C/W]	@ 1 W, 400 LFM [°C/W]	
HSB40-252510P	17.87	19.5	6.0	3.7	4.20

Note: 1. See performance curves for full thermal resistance details.

PERFORMANCE CURVES

Power (W)	Heatsink Temperature Rise Above Ambient (ΔT = T _{hs} - T _a) [°C]		
	Natural Conv.	200 LFM	400 LFM
0	0	0	0
1	19.5	6.0	3.7
2	37.6	11.8	7.3
3	55.0	17.9	11.1
4	71.8	23.8	14.7
5	87.6	30.0	18.4
6	102.0	36.0	22.2
7	116.2	42.0	26.1
8	129.1	48.0	29.8

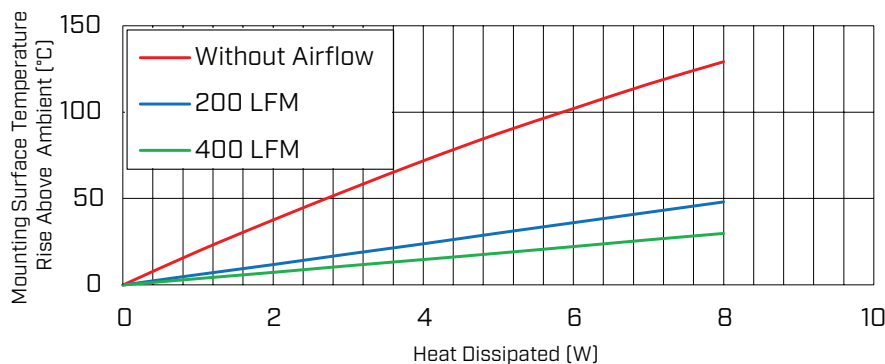

T_{hs}: "hot spot" temperature measured on the heatsink
 T_a: ambient temperature

MECHANICAL DRAWING

units: mm
tolerance: ±0.50 mm

MATERIAL	AL 6063-T5
FINISH	black anodized
PUSH PIN	nylon 66
SPRING	spring steel, zinc plated
WEIGHT	7 g

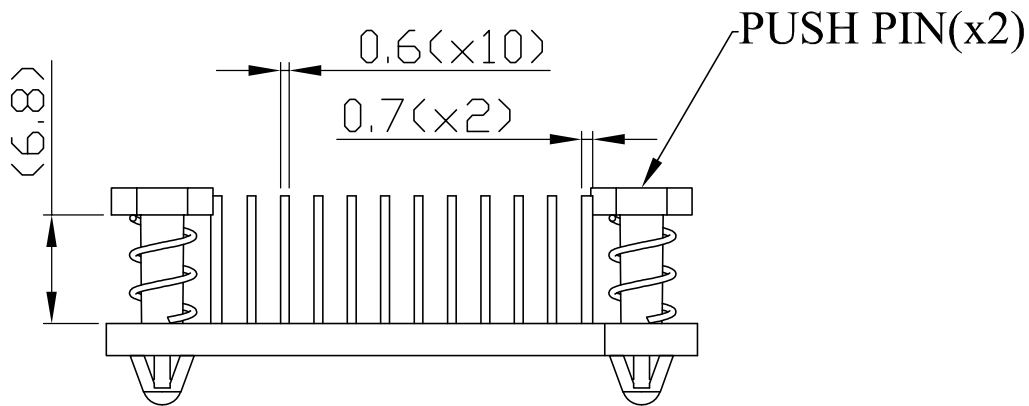
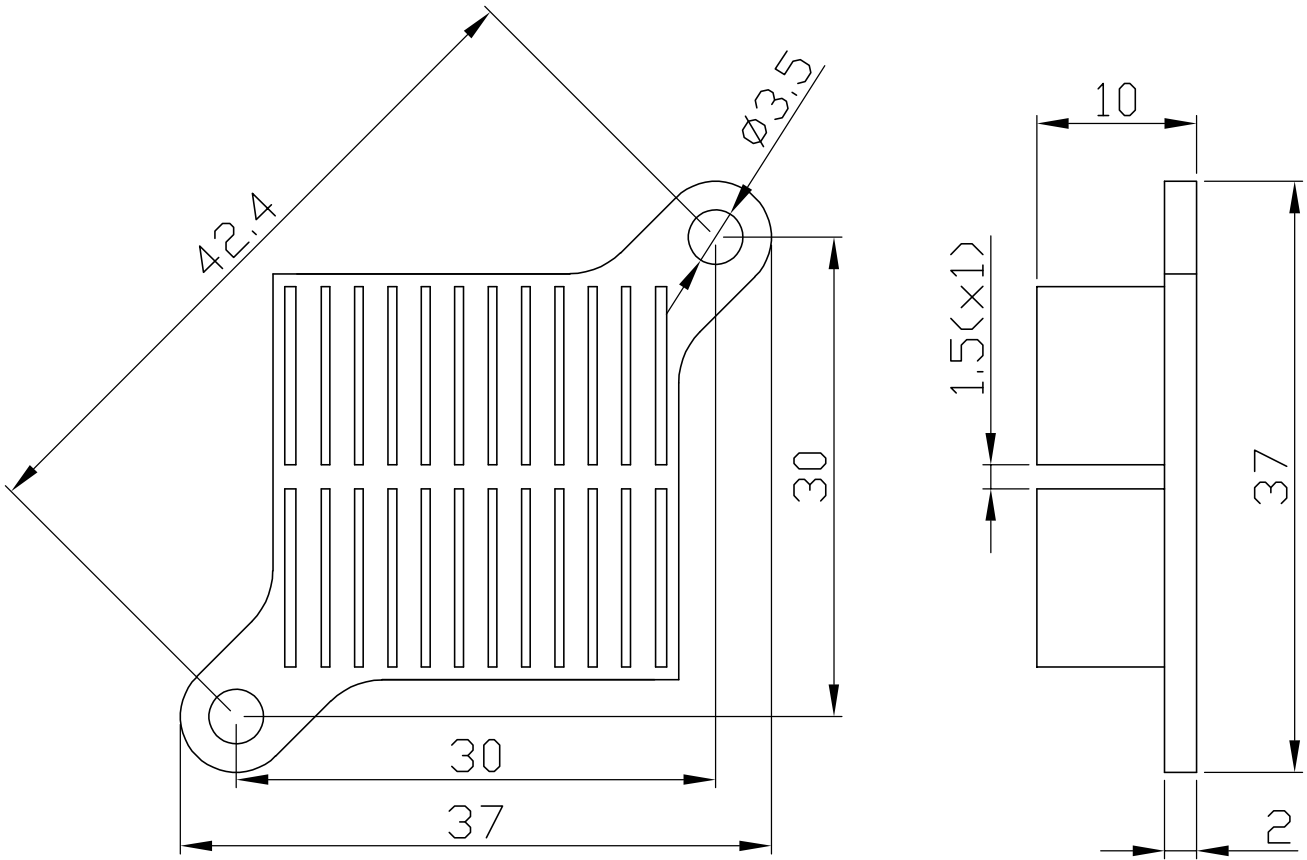

REVISION HISTORY

rev.	description	date
1.0	initial release	03/01/2024

The revision history provided is for informational purposes only and is believed to be accurate.



CUI Devices offers a one (1) year limited warranty. Complete warranty information is listed on our website.

CUI Devices reserves the right to make changes to the product at any time without notice. Information provided by CUI Devices is believed to be accurate and reliable. However, no responsibility is assumed by CUI Devices for its use, nor for any infringements of patents or other rights of third parties which may result from its use.

CUI Devices products are not authorized or warranted for use as critical components in equipment that requires an extremely high level of reliability. A critical component is any component of a life support device or system whose failure to perform can be reasonably expected to cause the failure of the life support device or system, or to affect its safety or effectiveness.

cuidevices.com