

MODEL: CMR-15062S-67 | **DESCRIPTION:** SPEAKER**FEATURES**

- IP67 rated face
- protection against dust and water ingress
- dynamic receiver
- small footprint
- spring contacts

**SPECIFICATIONS**

parameter	conditions/description	min	typ	max	units
input power			20	30	mW
impedance	at 1.0 kHz, 0.8 Vrms in free air	27.2	32	36.8	Ω
coil resistance		23.8	28	32.2	Ω
resonant frequency (Fo)	at 0.8 Vrms in free air	440	550	660	Hz
frequency response		300		7,000	Hz
sound pressure level	at 1 kHz with Type 3.2 HL Ear, 0.8 Vrms	114	117	120	dB
distortion	see THD curve				%
buzz, rattle, etc.	must be normal at sine wave, 0.3~7 kHz		0.8		Vrms
polarity	cone moves forward w/ positive dc current to "+" terminal				
dimensions	15 x 6 x 2				mm
magnet	Nd-Fe-B				
cone material	mylar				
weight			0.4		g
operating temperature		-20		70	$^{\circ}\text{C}$
storage temperature		-40		85	$^{\circ}\text{C}$
RoHS	yes				
IP level	IP67 (front side)				

Notes: 1. All specifications measured at 15~35 $^{\circ}\text{C}$, humidity at 25~75%, under 86~106 kPa pressure, unless otherwise noted.

MECHANICAL DRAWING

units: mm
tolerance: ±0.2 mm

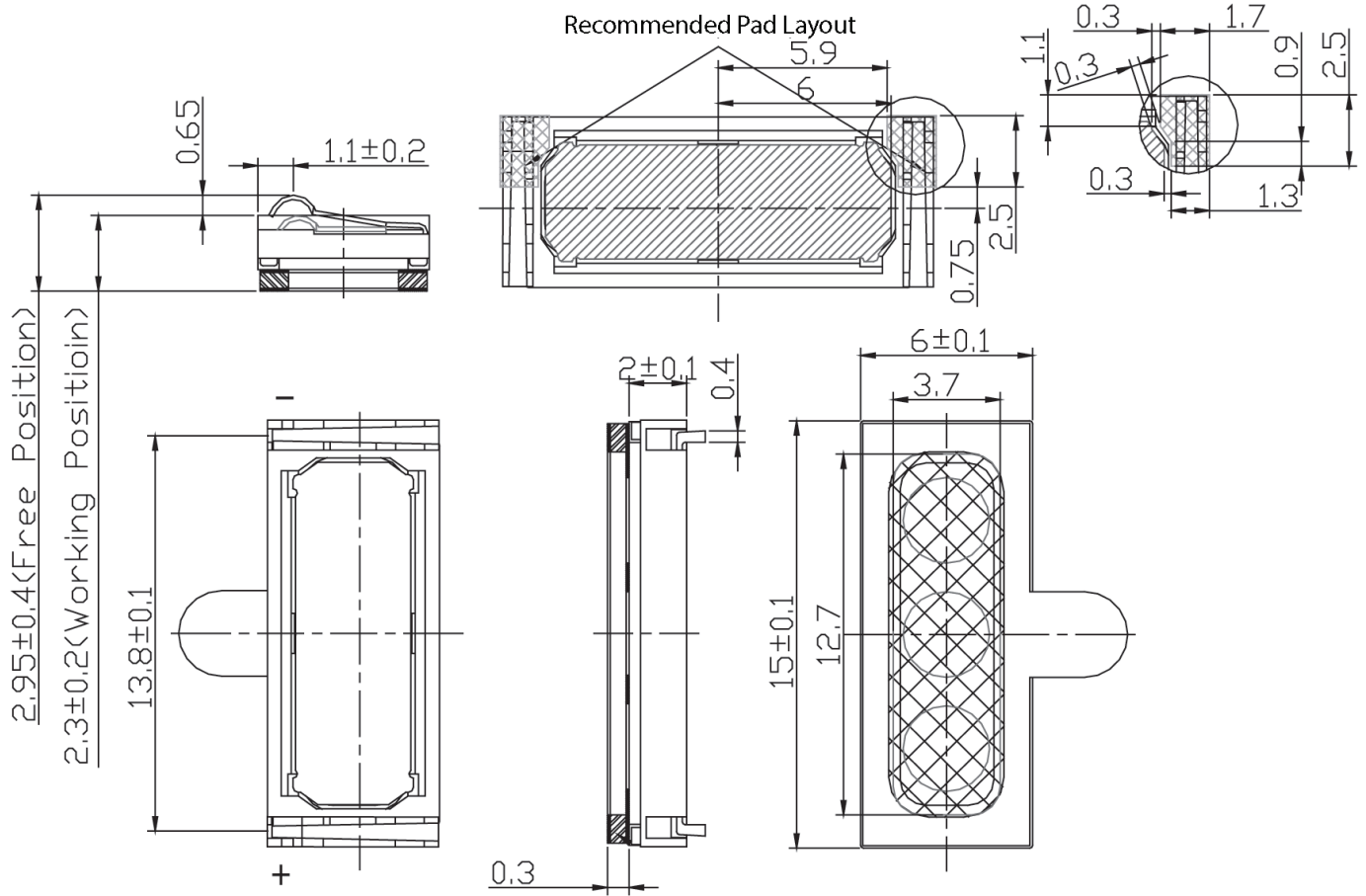

MECHANICAL DRAWING (GASKET)

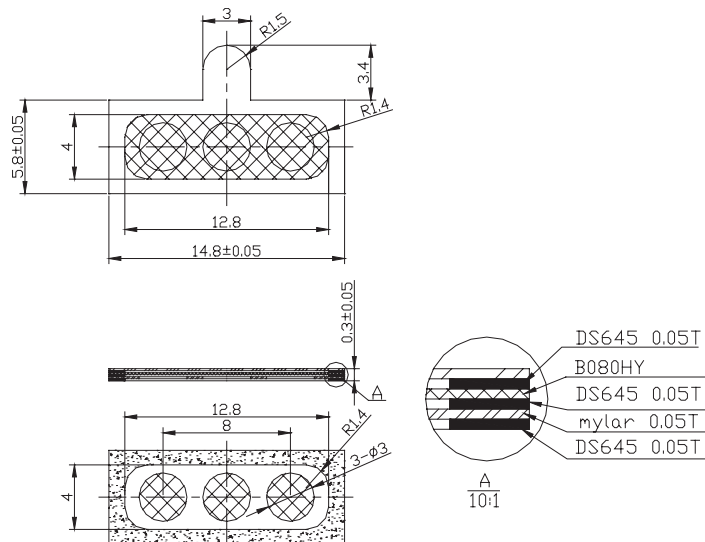

RESPONSE CURVES

Frequency Response Curve

Test Conditions: 0.8 Vrms / Type 3.2 HL Ear

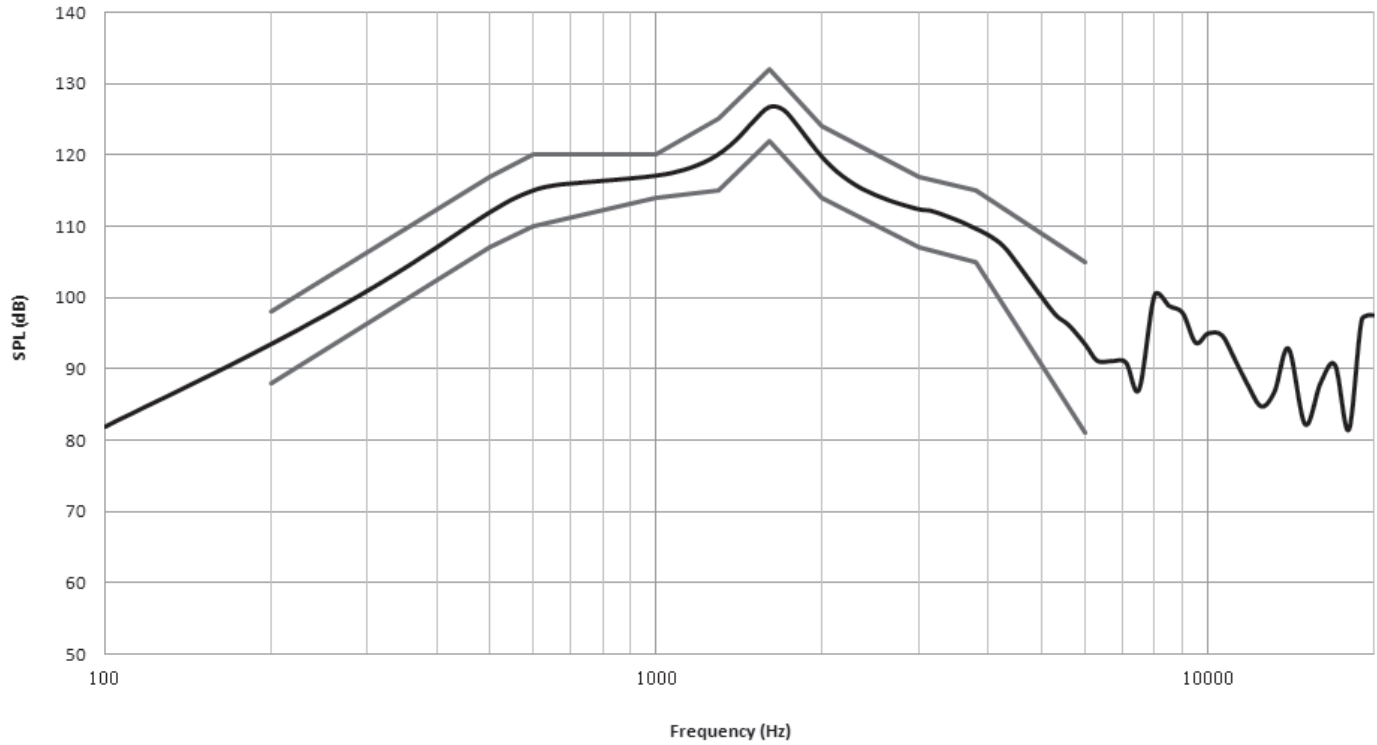

Total Harmonic Distortion Curve

Test Conditions: 0.8 Vrms / Type 3.2 HL Ear

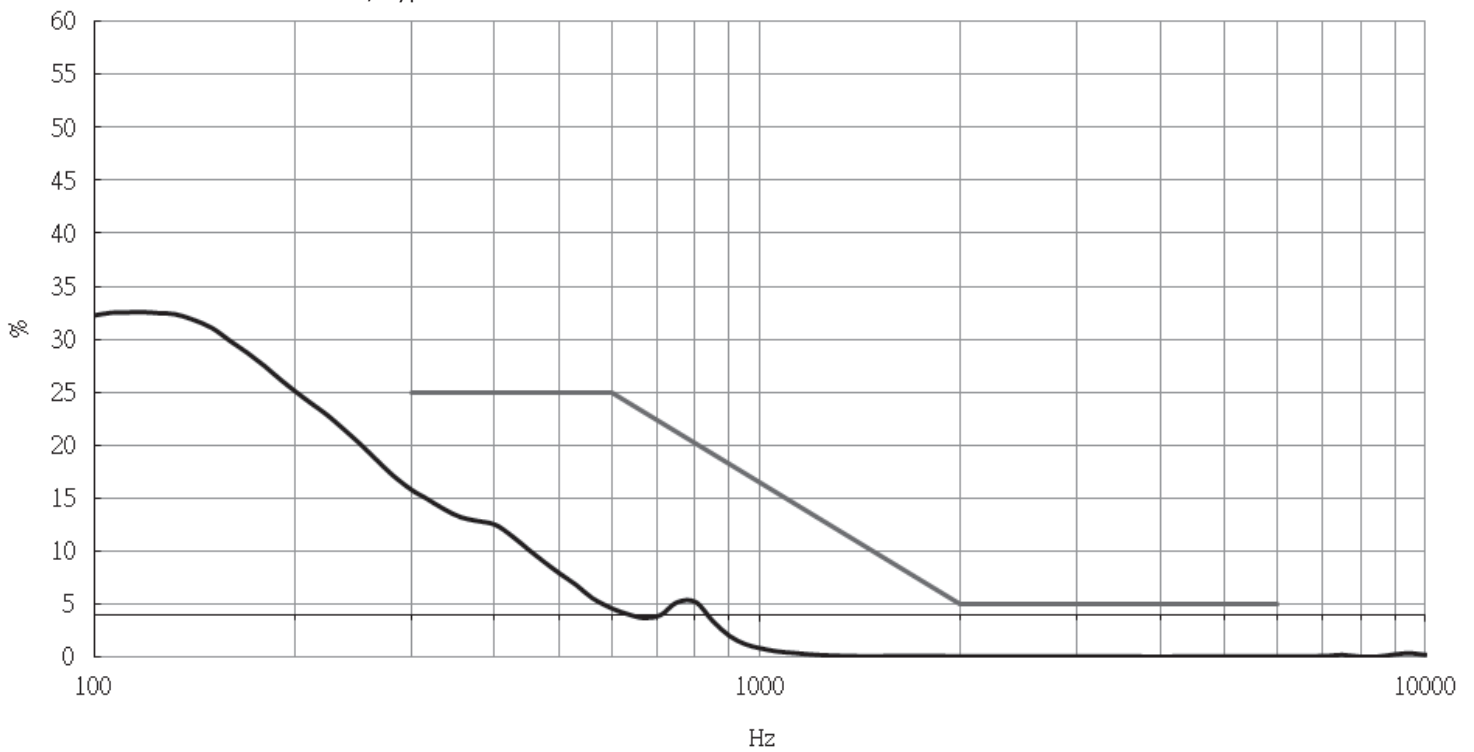

PACKAGING

units: mm

Tray QTY: 200 pcs per tray
 Carton Size: 345 x 260 x 390 mm
 Carton QTY: 6,800 pcs per carton

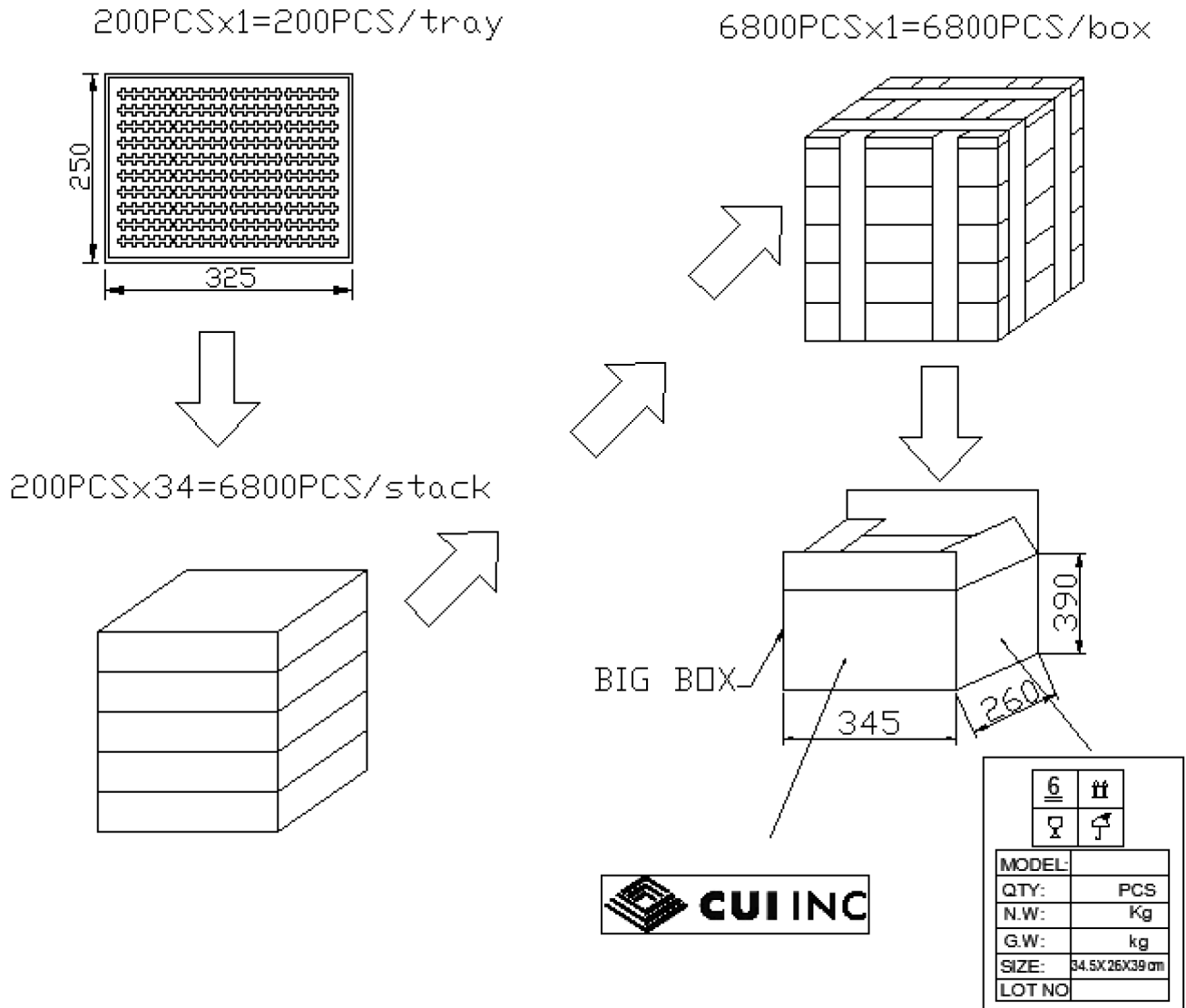

REVISION HISTORY

rev.	description	date
1.0	initial release	07/24/2018
1.01	brand update	01/23/2020

The revision history provided is for informational purposes only and is believed to be accurate.

CUI DEVICES

CUI Devices offers a one (1) year limited warranty. Complete warranty information is listed on our website.

CUI Devices reserves the right to make changes to the product at any time without notice. Information provided by CUI Devices is believed to be accurate and reliable. However, no responsibility is assumed by CUI Devices for its use, nor for any infringements of patents or other rights of third parties which may result from its use.

CUI Devices products are not authorized or warranted for use as critical components in equipment that requires an extremely high level of reliability. A critical component is any component of a life support device or system whose failure to perform can be reasonably expected to cause the failure of the life support device or system, or to affect its safety or effectiveness.