

**SERIES:** AMT30 | **DESCRIPTION:** MODULAR ENCODER

**FEATURES**

- U, V, W commutation lines
- small size 37 mm
- line count up to 1024 PPR
- optional line driver output (303LD)
- single pulse index
- capacitive ASIC technology
- modular locking hub design for ease of installation
- 2, 4, 6, 8, 10, 12, or 20 pole motors
- 6 programmable functions
- 'One Touch' commutation signal alignment

**ELECTRICAL**

parameter	conditions/description	min	typ	max	units
power supply		4.5	5	5.5	V
current consumption	with unloaded outputs		8	10	mA
commutation output signals	U, V, W phase				
commutation pole	2, 4, 6, 8, 10, 12, 20 (software programmable)				
incremental output signals	A, B, Z (AMT303) A, $\bar{A}$ , B, $\bar{B}$ , Z, $\bar{Z}$ (AMT303LD)				
incremental output waveform	quadrature output square wave				
quadrature output resolutions	96, 192, 200, 250, 384, 400, 500, 512, 800, 1000, 1024				PPR
index	one pulse per 360 deg.				
quadrature output current	AMT303 (single ended) sink/source AMT303LD (differential) sink/source			2 20	mA
position accuracy			0.2		deg

**MECHANICAL**

parameter	conditions/description	min	typ	max	units
max. rotational speed				8,000	RPM
mounting options	A) 2 x M1.6 on 16 mm (0.63") bolt circle B) 2 x #4 on 19.05 mm (0.75") bolt circle C) 2 x M1.6 or M2 on 20 mm (0.787") bolt circle D) 3 x M1.6 or M2 on 20.9 mm (0.823") bolt circle with washers in option B holes E) 3 x M1.6 or M2 on 22 mm (0.866") bolt circle F) 4 x M1.6 or M2 on 25.4 mm (1") bolt circle				
axial play				±0.4	mm

**ENVIRONMENTAL**

parameter	conditions/description	min	typ	max	units
operating temperature		-40		125	°C
humidity	non-condensing			85	%
vibration	10 ~ 500 Hz, 5 min. sweep, 2 hours each XYZ			5	G
shock	3 pulses, 6 ms, 3 each XYZ			200	G

## PART NUMBER KEY

For customers that prefer a specific AMT303 configuration, please reference the custom configuration key below.

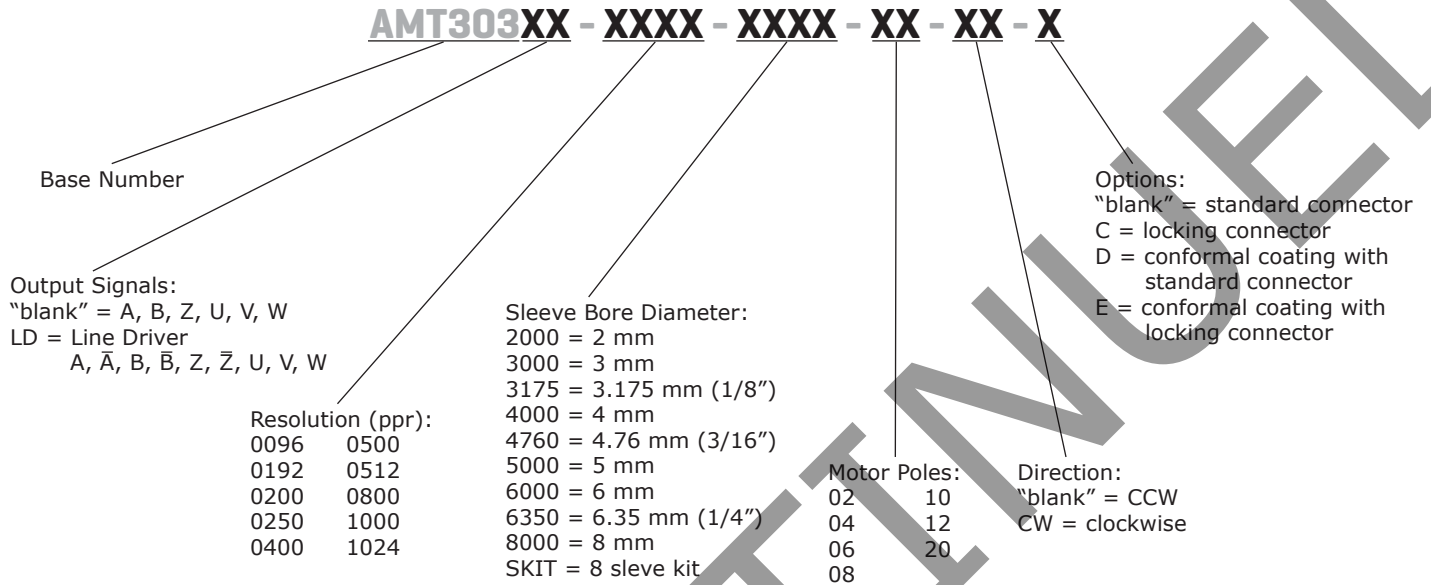

## AMT303 KITS

In order to provide maximum flexibility for our customers, the AMT303 series is provided in kit form standard. This allows the user to implement the encoder into a range of applications using one sku#, reducing engineering and inventory costs.

SLEEVES								
8mm	1/4 inch (6.35mm)	6mm	5mm	3/16 inch (4.76mm)	4mm	1/8 inch (3.175mm)	3mm	2mm
Blue	Snow	Red1	Green1	Yellow1	Gray60	Purple1	Orange	Light Sky Blue

## ORDERING GUIDE

### AMT303XX-V

Output Signals:  
 "blank" = A, B, Z, U, V, W signals  
 LD = Line Driver  
 A,  $\bar{A}$ , B,  $\bar{B}$ , Z,  $\bar{Z}$ , U, V, W signals

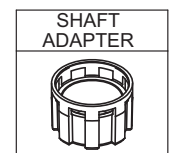
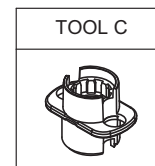
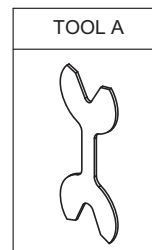
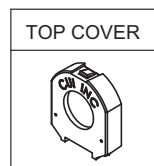
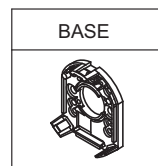

## ENCODER INTERFACE

### Standard Connector Option

### Locking Connector Option

PINOUT CONNECTOR 1		
	Function	
#	AMT303	AMT303LD
14	GND_C <sup>1</sup>	GND_C <sup>1</sup>
13	N/A	-Z
12	Z	Z
11	N/A	-A
10	A	A
9	N/A	-B
8	B	B
7	V	V
6	5 V+	5 V+
5	W	W
4	GND	GND
3	U	U
2	zero set	zero set
1	N/A	N/A

Notes: 1. GND\_C is mode selection line used at startup to determine encoder mode:  
 VCC/Floating: SPI Communication Mode  
 Ground: Normal Operation Mode  
 Standard use requires attaching GND\_C  
 Pin# 14 to GND in order to get Commutation output.  
 SPI Communication mode allows the user to write parameters to the encoder via SPI link, contact CUI Inc. for more details.

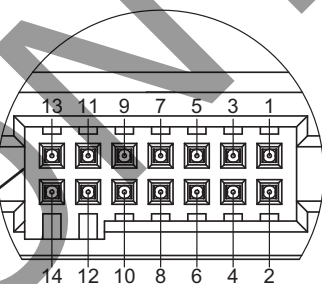
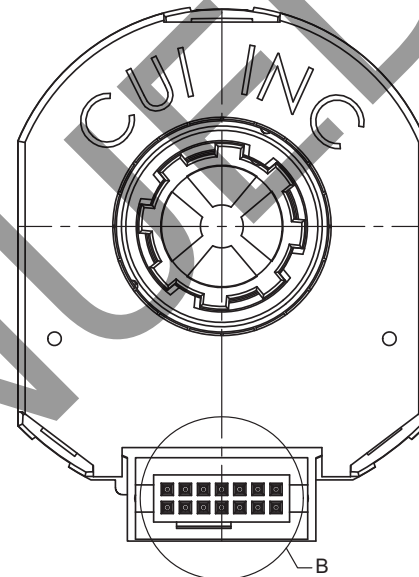
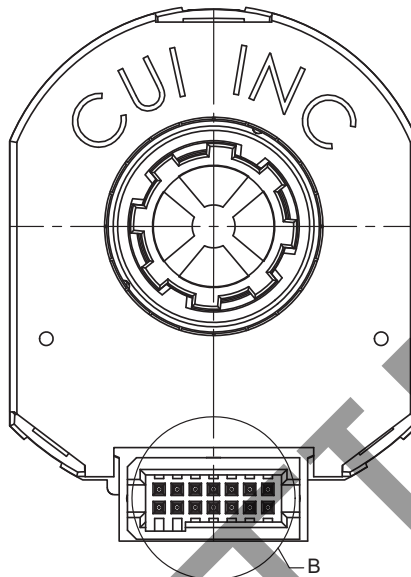

Mating Connector:  
Samtec ISDF-07-D

DETAIL B  
SCALE 4 : 1

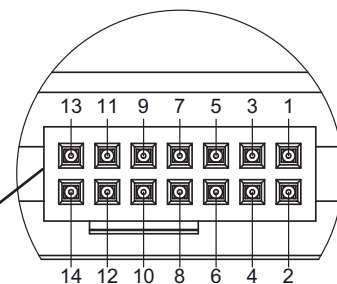

Mating Connector:  
Samtec ISDF-07-D-L

DETAIL B  
SCALE 4 : 1

### Encoder Side

### Demo Board Side

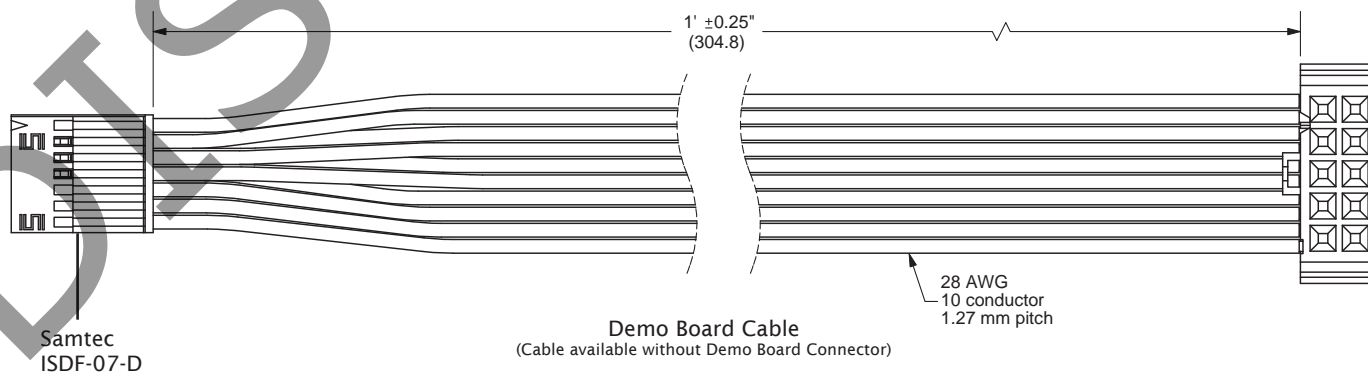

## MECHANICAL DRAWING

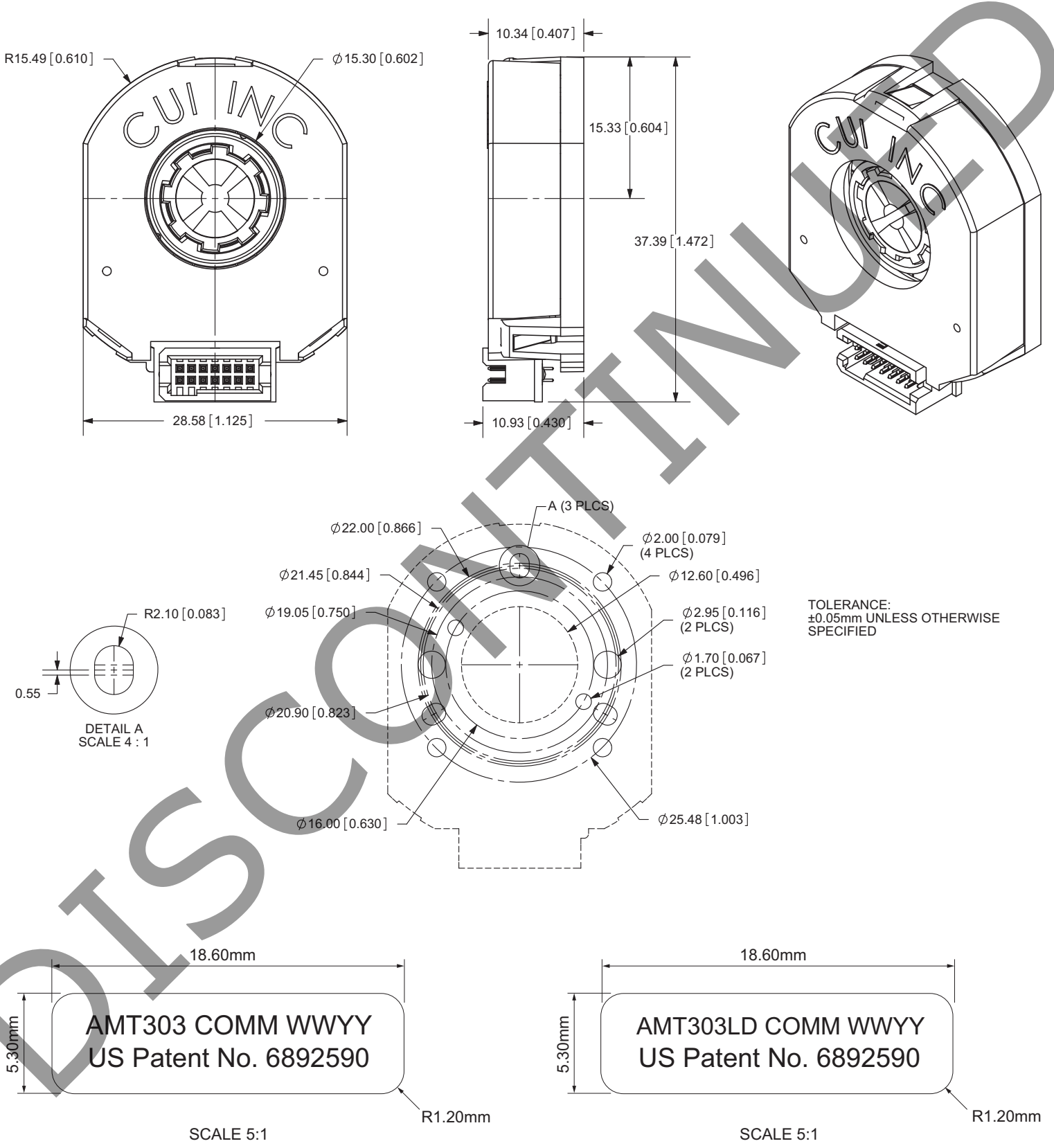

## ENCODER OPERATIONAL MODE

### Initialization mode:

- At power up the encoder goes through an initiation and stabilization procedure. This includes microprocessor stabilization and the program for combining Coarse and Fine channel of the encoder for getting the absolute start position. This takes less than 0.1 seconds.

### Tracking mode:

- MCU 12 bit position register is updated from Fine Asic every 48  $\mu$ s.
- The commutation program in the MCU has a compensation for the average delay caused by the update rate, leaving a remaining jitter of less than 24  $\mu$ s RMS.
  - The communication jitter expressed in electrical degrees will be proportional speed and does not reach 6 deg RMS until the speed reaches the following values:

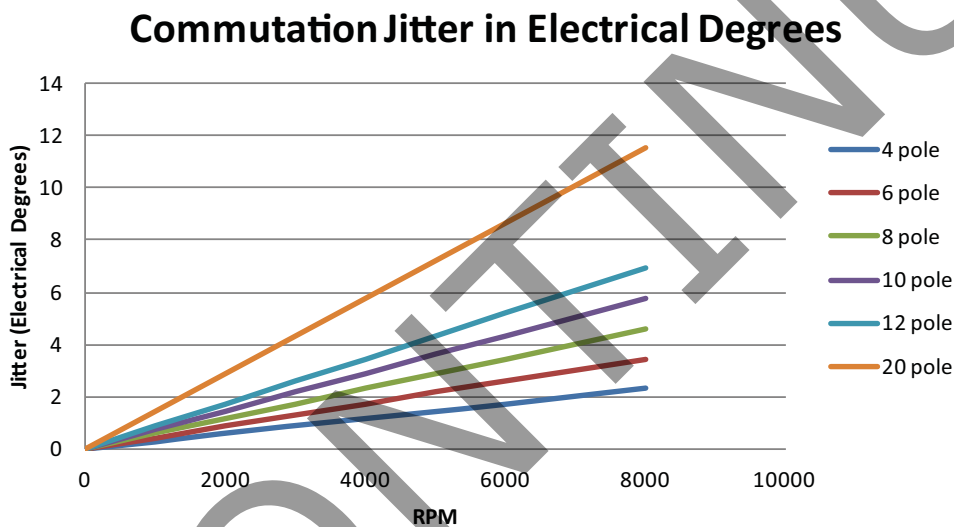

## COMMUTATION ALIGNMENT AND SETTING THE ZERO POINT

We strongly recommend the use of the AMT303 series demo board to set commutation zero. It greatly simplifies and expedites the process. The demo board also allows setting of resolution, # of motor poles, direction of quadrature increment, and commutation angle offset (when required). If you do not have or cannot obtain a demo board, use the following procedure to align the AMT303XX commutation angle with your motor:

1. Mount the AMT303 series encoder to the motor.
2. Put the motor in a 'locked rotor' condition. Consult your motor manufacturer if you are not certain how to lock the rotor for commutation alignment.
3. With the motor in a locked rotor position, pull pin# 2 (zero set) low, tie Pin 2 to Ground, to write the rotor position into non-volatile memory in the encoder.
4. Power cycle the encoder, i.e., remove power from it. The commutation position is now permanently aligned with the motor rotor zero position and will use this offset at initialization every time at startup.

Note: *The procedure is based on the standard "WYE" motor phase connection configuration. If your motor uses other than the "WYE" phase connection, you must acquire the AMT303 series demo board to program the required offset to align encoder commutation signal zero with motor zero position.*

## REVISION HISTORY

rev.	description	date
1.0	initial release	05/04/2011
1.01	updated electrical specifications	06/10/2011
1.02	updated pin-out and speed specification	09/21/2011
1.03	addition of commutation jitter, shock, speed, and position accuracy, updated part number key	09/30/2011
1.04	updated Part Number Key	03/09/2012
1.05	clarification notes	08/17/2012
1.06	added locking connector drawing	03/29/2013
1.07	updated spec	01/30/2014
1.08	added axial play specification	03/25/2014

The revision history provided is for informational purposes only and is believed to be accurate.



**Headquarters**  
20050 SW 112th Ave.  
Tualatin, OR 97062  
**800.275.4899**

Fax 503.612.2383  
**cui.com**  
techsupport@cui.com

CUI offers a one (1) year limited warranty. Complete warranty information is listed on our website.

CUI reserves the right to make changes to the product at any time without notice. Information provided by CUI is believed to be accurate and reliable. However, no responsibility is assumed by CUI for its use, nor for any infringements of patents or other rights of third parties which may result from its use.

CUI products are not authorized or warranted for use as critical components in equipment that requires an extremely high level of reliability. A critical component is any component of a life support device or system whose failure to perform can be reasonably expected to cause the failure of the life support device or system, or to affect its safety or effectiveness.